

New platform

nanoCAD Mechanical 20.1 is based on the updated nanoCAD Plus 20.1.

Offset dimension

Dimension types in previous versions of nanoCAD Mechanical had some limitations:

- no dimension is possible to set to the spline;
- when placing a dimension on a polyline, the dimension text does not correspond to the length of the polyline;
- ellipse (elliptical arc) can't be dimensioned.

New dimension type was implemented. It is named "Offset dimension".

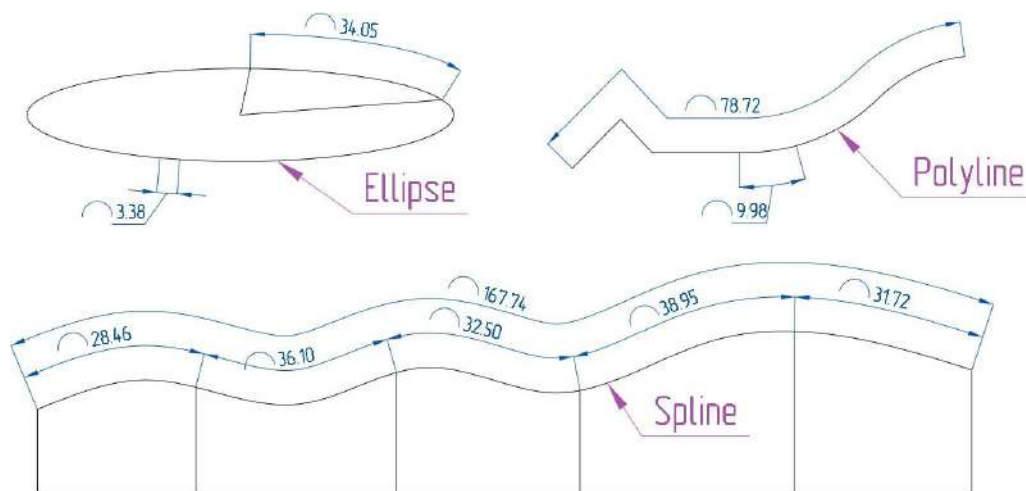

Detail view with auto update

Functionality of detail views was reworked. New detail view is created as a single object and is updated by the "MCREGEN" command when the source data is changed.

If at least one scaled object (or any part of this object) falls into the view frame, then its scale is taken into account for the entire detail view. If several library objects scaled differently fall into the view frame, then the scale of one of the objects within the frame is taken into account.

Text on drawing was improved

It is possible to create unnumbered lists that begin with "dots" or "dashes" in the text of technical requirements and technical characteristics

There is new setting "Font size for fractions". This setting toggles the display options for fractions. There are two options for displaying fractions:

- with indices one notch less than the font size of the main value to which they are assigned;
- with indices of the same size with the font size of the main size.

Previously, only the first display option was available.

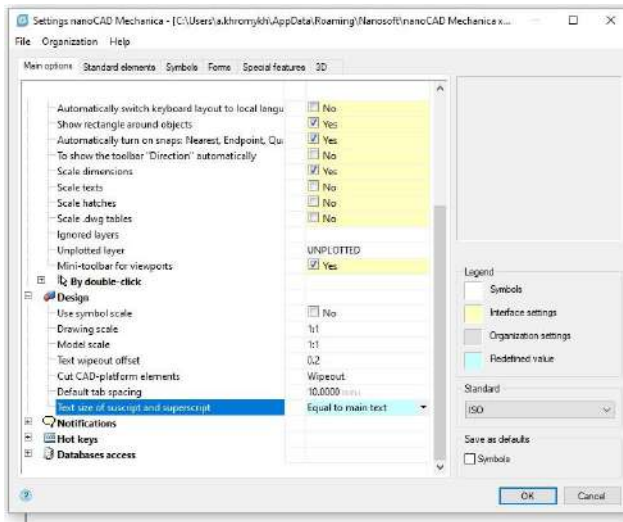

Base of elements

Fasteners were added to the database according to the standards: BS EN, CSN EN, DIN EN, NF EN, SFS EN, SS EN, STN EN, UNI EN, DIN EN.

3D Thread

New function "3D Thread" - command line command "3DTHREAD", or button "3D Thread" on the ribbon tab "3D tools" in the group "Editing", or drop-down menu "3D" -> "3D Elements"-> "3D Thread" of the classic interface.

The 3D Thread tool is designed to indicate threads in 3D models of parts and assemblies.. In accordance with the specified diameter, the system will offer possible options for the thread pitch. Additionally, you can select the direction of the thread, the depth of the thread, and the edge relative to which the thread depth is set. Threads on models can be chamfered and / or filleted.

Thread visual representation can be adjusted in the "3D" tab in the "General settings" section. There is a choice of surface and thread spiral colors, as well as a setting that allows you to hide the thread spiral and designate the thread only with a surface.

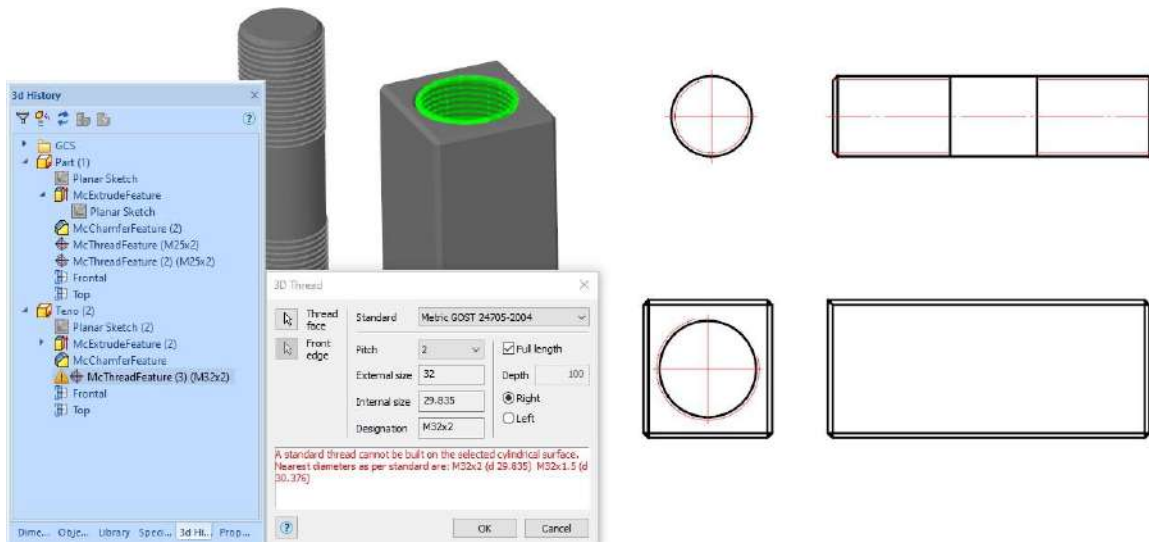

In projection views of 3D models with a thread, obtained by projection onto a plane parallel to the axis of the thread, the thread is indicated by thin lines. In projection views of 3D models with a thread, obtained by projection onto a plane perpendicular to the axis of the thread, the thread is indicated by an arc $\frac{3}{4}$ of a circle.

Auto-adjust hatches for 3D solids sections

The command "DRAWINGVIEWAUTOHATCH" or the "Set hatching of sections" button of the ribbon "3D- tools" in the group "2D Views", or the same button of the drop-down menu 3D -> 2D Views allows you to automatically make different (by the angle of inclination and by step) hatches of parts in the views with sections. In this case, the same part will be shaded in the same way in all sections.

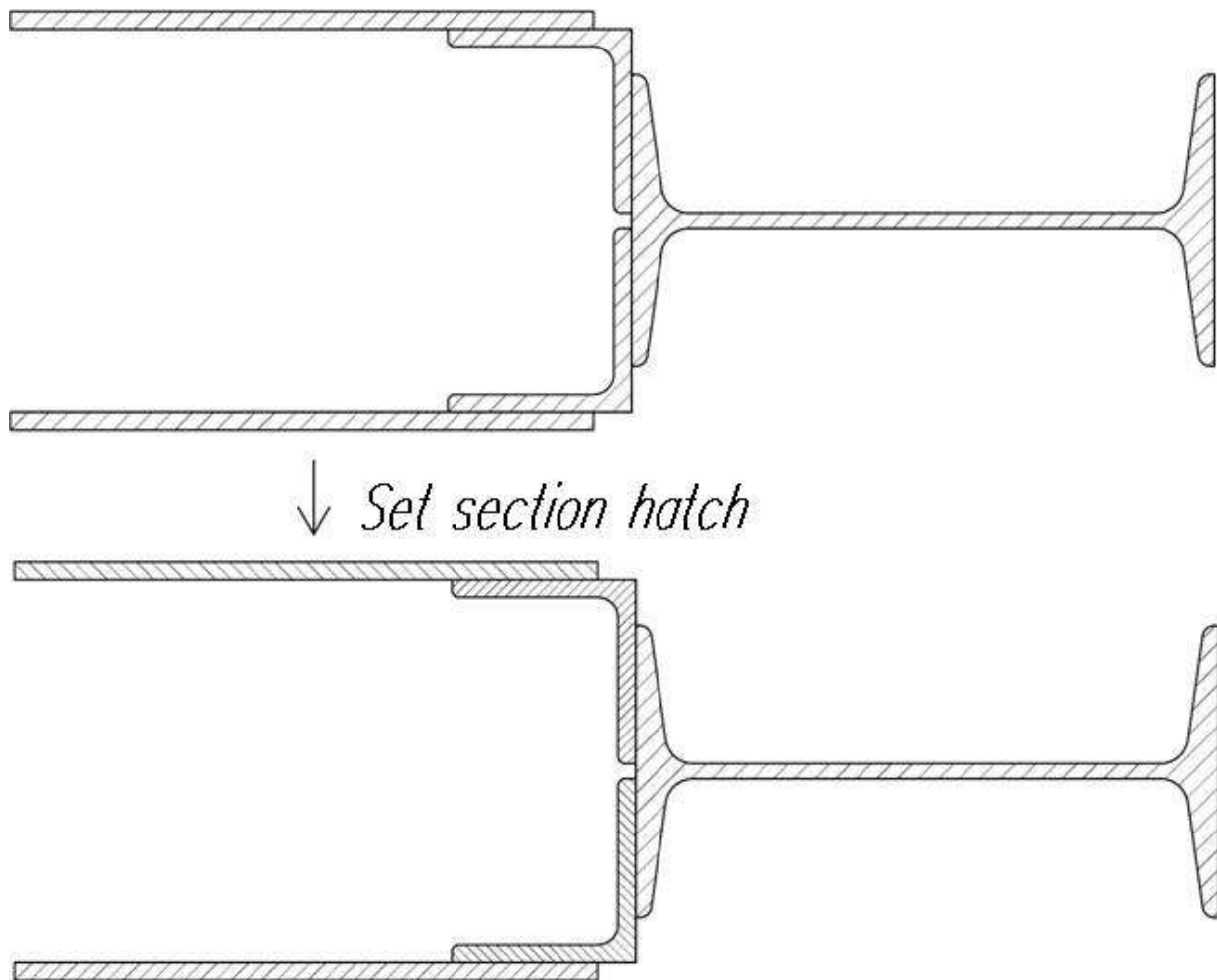

New 2D Sketch Features

In the settings of vertical applications on the "3D" tab, in the "General settings" section, the "Associativity when creating new bodies" setting has appeared. If this setting is disabled, then new bodies created on the surfaces of existing bodies can be easily rearranged to a new position. At the same time, in the 3D operations dialog box, it is possible to locally switch this mode for the new body being created.

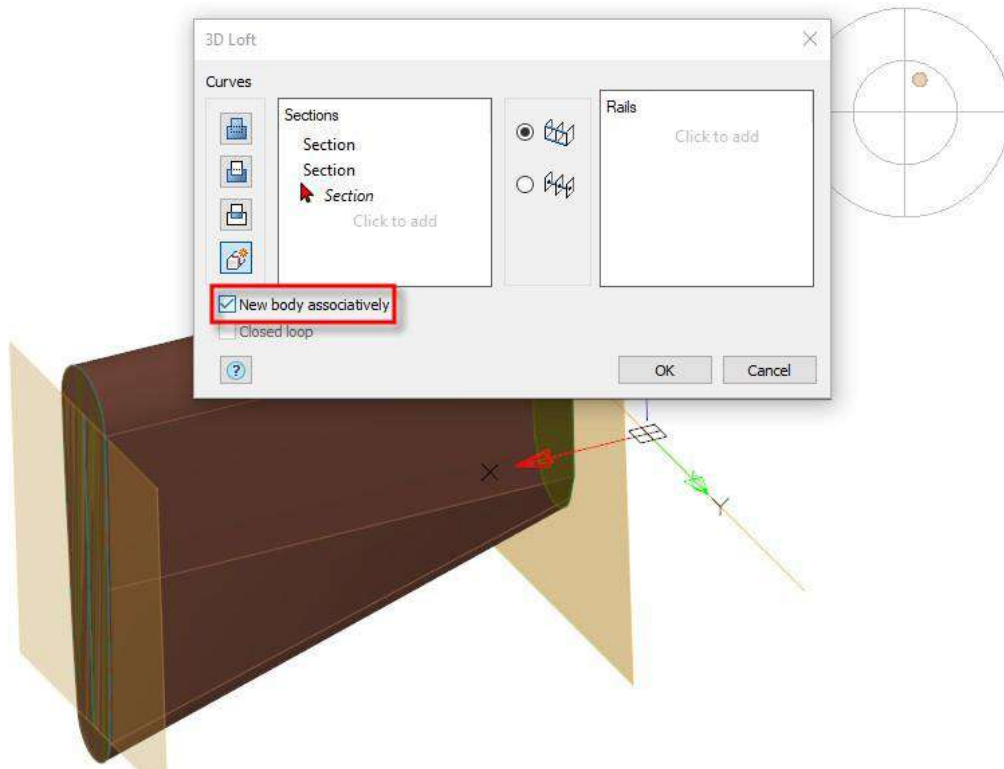

The “Automatic projection of the origin of coordinates onto the sketch” setting was added in the “General settings” section on the “3D” tab of the “Settings” dialog box.

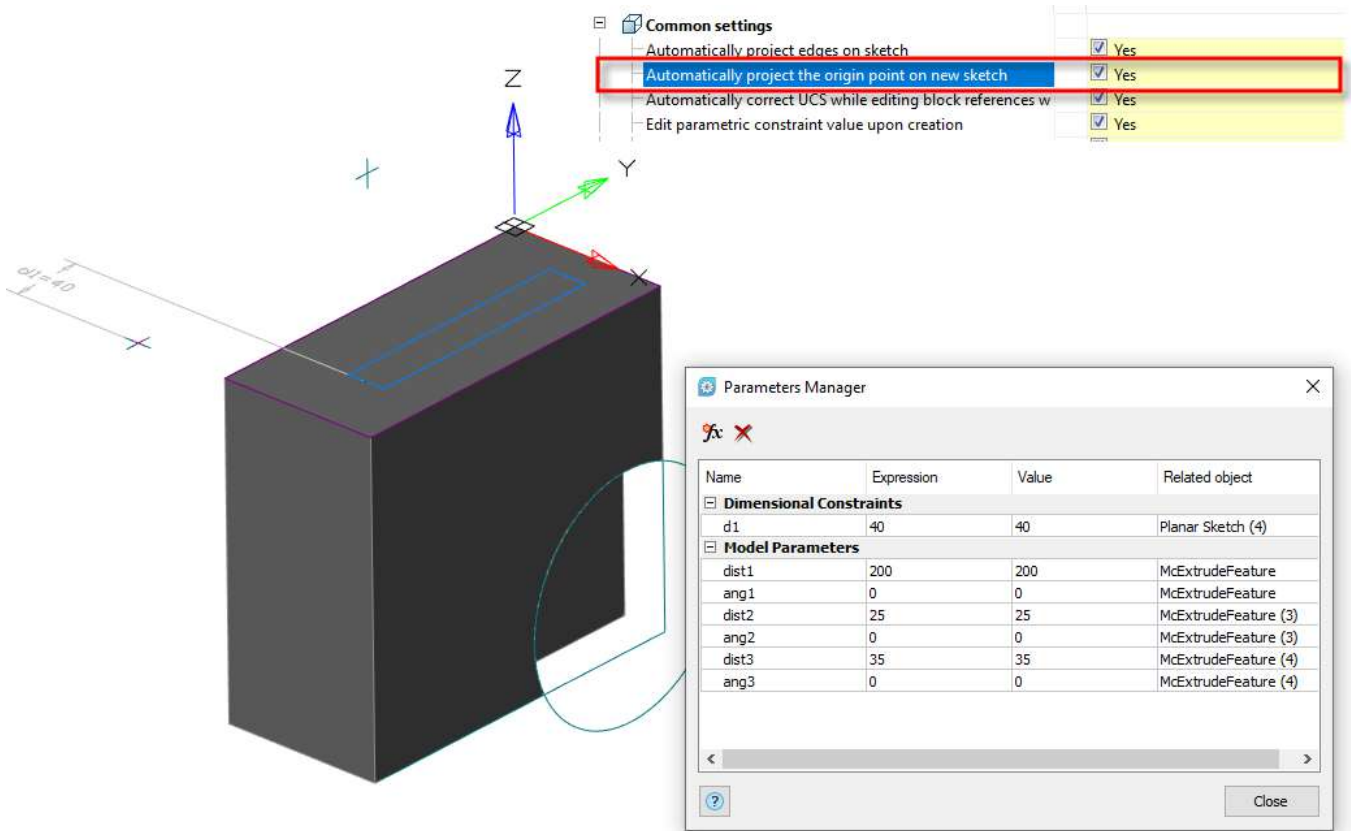

The “PSDEFINECS” command allows you to override the 2D Sketch coordinate system. The origin of the 2D Sketch can be aligned with any point of the geometry projected onto the sketch, and the position of any axis can be specified in an arbitrary direction relative to any rectangular edge of the sketch, and the second axis will be automatically rebuilt accordingly.

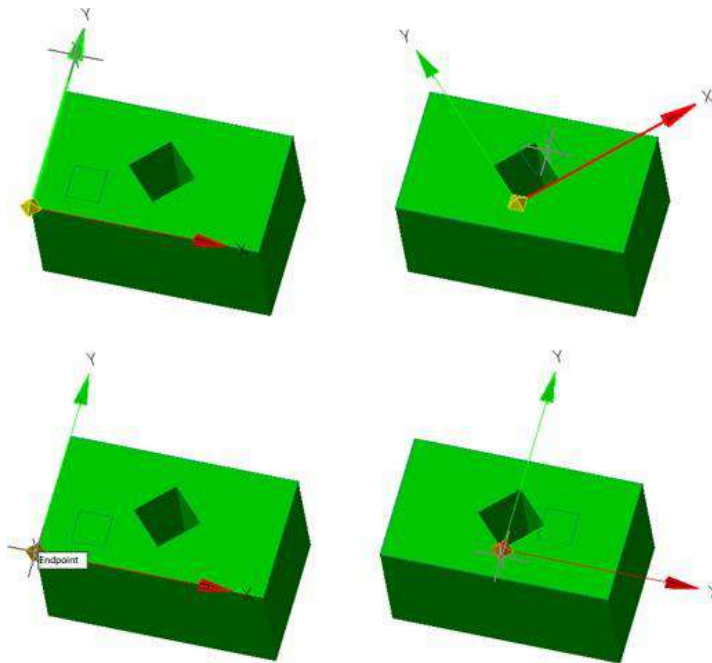

Now, the 3D spiral can be used as a path for drawing solids with the Sweep operation, as well as the centerline of the Loft operation.

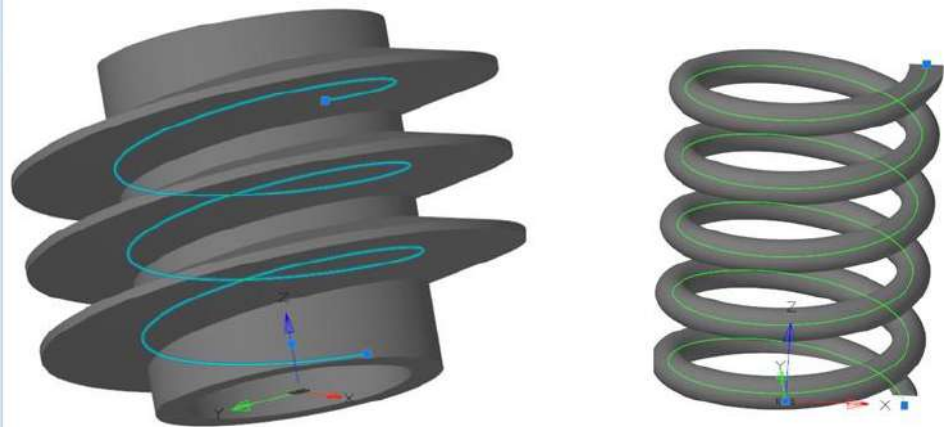
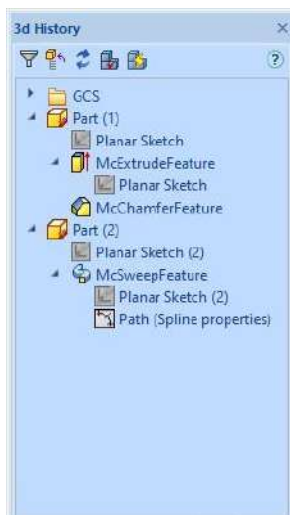

Other changes

- The reliability of the 3D object transformation commands (MOVE / ROTATE / 3DMOVE / 3DROTATE / DRAGDROP) has been significantly improved.
- Fixed bugs when working with blocks containing 3D construction elements.
- Classic and Ribbon User Interfaces were improved.
- Added the ability to create axial lines of circles, the centers of which are on the same straight line, as well as the ability to create axes for single arcs.
- Added symbols "Not equal" and "Identically" to the font.
- Added symbol to denote Unequally-disposed modifier tolerance.
- Improved dimensioning in the UCS.